

Welcome to digital TV



For a one off payment, you can buy a digital box, satellite dish and installation giving you over 80 channels covering the best of TV and more.

The big switchover

Over the next 4 years, the old analogue TV signal is gradually being switched off. Soon you'll only be able to watch television with a digital receiver.

www.digitaluk.co.uk also offers information about when the analogue signal is being switched off in your area.

Need extra information or help setting up?

You may find the information you are looking for on our website.

www.goodmansdigital.co.uk

or on the freesat website.

www.freesat.co.uk

If you still need help or information you can phone our call centre on:

0871 230 4695

Calls are charged at 10p per minute when called from a BT land line. Call charges may vary if using other networks.

Goodmans

GFSAT100SD
HD digital box

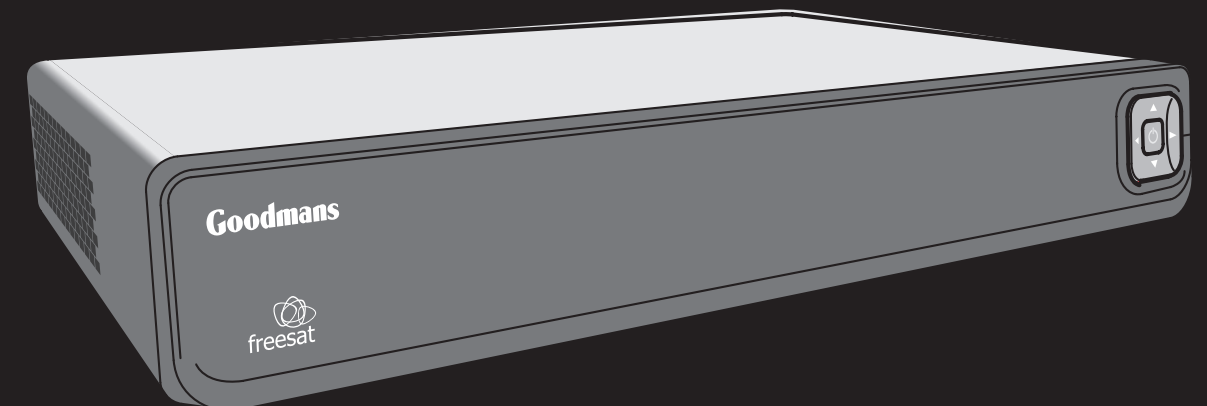

Start here

1

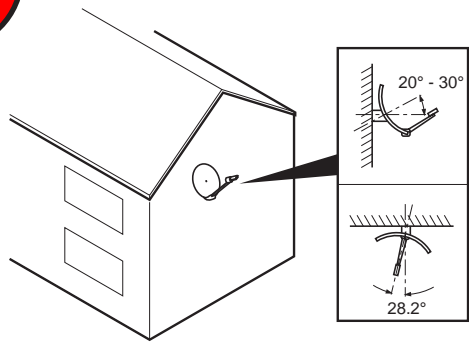

Install your satellite dish strictly following local council rules and regulations. The dish should face 28° East of South with an inclination of between 20° and 30°.

2

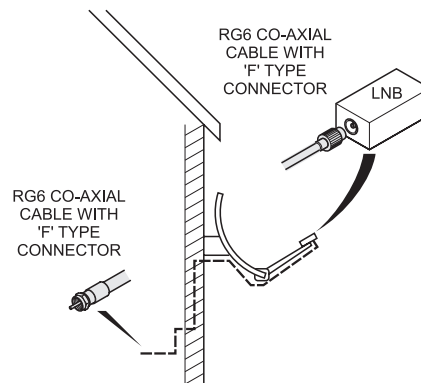

Connect a suitable RG6 Co-axial cable with a 'F' type connector to the LNB. Route the remaining end of the cable through the external wall and connect a 'F' type connector.

3

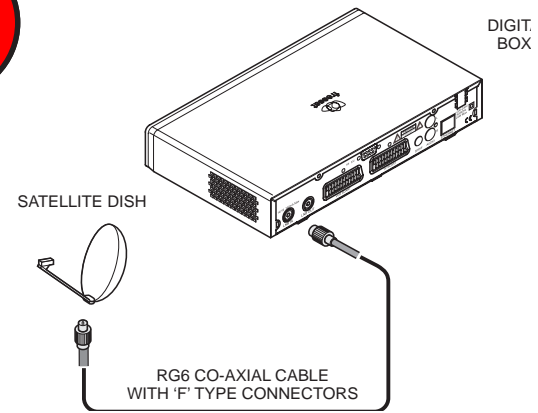

Connect the loose end of the RG6 Co-axial cable with the 'F' type connector fitted to the 'LNB IN' socket on the back of the digital box.

4

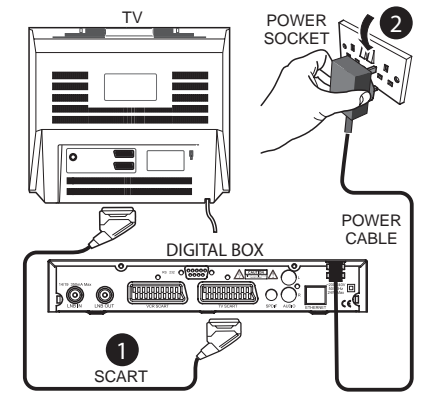

Connect the SCART cable (supplied) between your TV and the digital box. Connect the mains plug and then turn the power socket On.

5

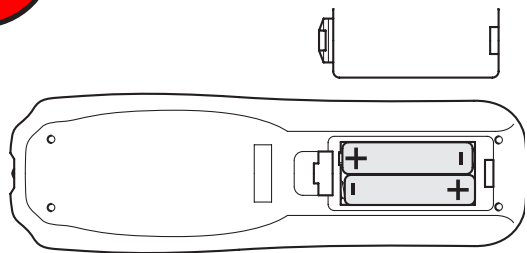

Remove the battery cover from the remote control and insert 2 x AAA batteries into the battery compartment.

6

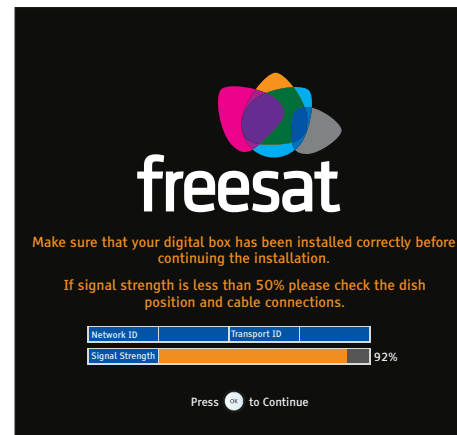

The first install screen will appear. If the signal strength is above 50% press the OK button to continue. If below 50% check the dish alignment and cable connections.

7

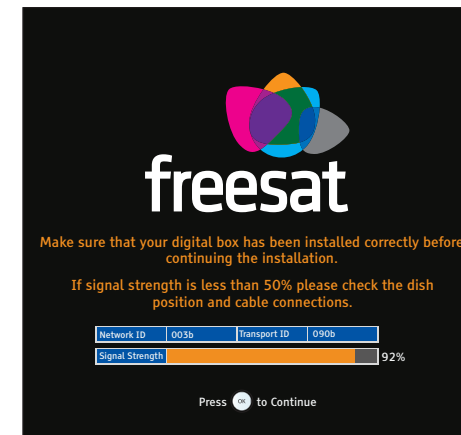

The Network ID and Transport ID are shown. Press the OK button to download available software updates.

8

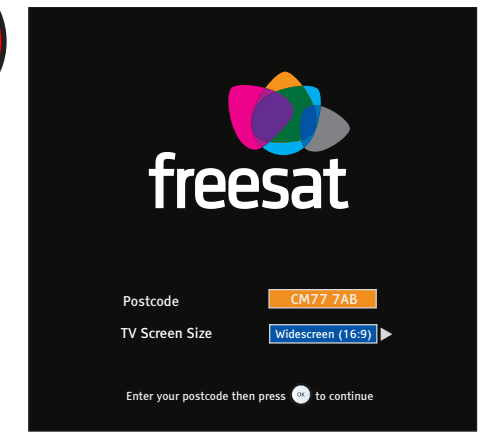

Use the number keys on the remote control to enter your postcode. The right arrow moves to the next space and the left arrow deletes the previous character. Press the OK button to continue.

9

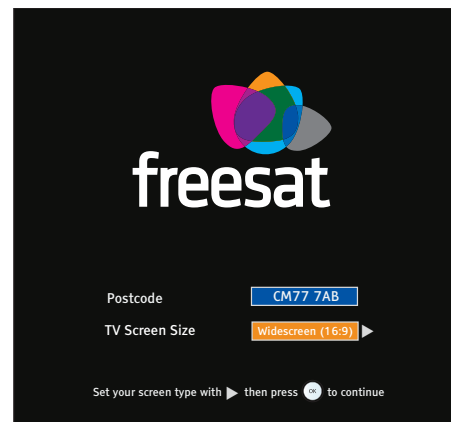

Use the left arrow to choose the TV screen size that matches your TV. Press the OK button to continue.

10

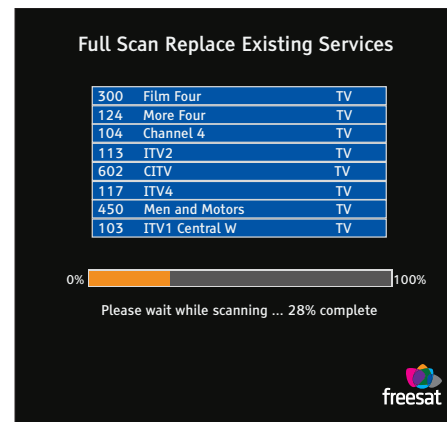

Your digital box will now autotune.

11



Press the GUIDE button on your remote control to see the channel types available.

You are now ready to watch tv. To learn more about your digital box look in the main instruction manual.